

WINE MASTER

le temps d'être différent



WinePC15

Installation and user guide

INFORMATION STATED ON THE NAMEPLATE OF THE APPLIANCE :

- Model :
- Serial N° :
- Date of purchase :

IMPORTANT :

It is recommended to note the serial number here above. It will be necessary for ordering spare parts and for warranty.

01.03.2017

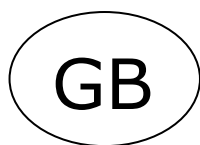

CONTENTS

1. General Information	Page 4
1.1 Technical data	Page 4
1.2 Dimensional drawing	Page 5
1.3 Packages content	Page 6
2. Some advices.....	Page 7
2.1 Wine ageing	Page 7
2.2 Rejection room.....	Page 7
2.3 The cellar	Page 8
2.3.1. Insulation	Page 8
2.3.2. Insulation of walls and ceiling	Page 9
2.3.3. Insulation of the floor.....	Page 9
2.3.4. Insulation of other elements.....	Page 9
3. Door installation	Page 9
4. Installation of the air conditioner	Page 12
5. Using the air conditioner	Page 13
5.1 Temperature setting	Page 14
5.2 Standby mode	Page 14
5.3 Automatic defrost	Page 14
6. Air conditioner maintenance	Page 15
7. Warranty	Page 15
7.1 Contractual warranty	Page 15
7.2 2 years contractual warranty	Page 15
7.3 Warranty conditions	Page 15
7.4 Exclusions and warranty limitations	Page 16

Introduction

You purchased an air conditioner WINEMASTER® and we thank you for your confidence.

From conception to commercialisation, everything has been implemented to offer an exclusive and high quality product. Brainchild of a team who find in this a motivation to ever give satisfy you, we hope that your wine conditioning unit WINEMASTER® will bring you great storage and best wines aging for an incomparable pleasure.

Because the customer is at the heart of all our thoughts, we want to support you in your first steps and lead you towards the best use of your air conditioner every day. Thus, you will find in this manual technical information and practical advice to help you to deal with the essential steps to installation and use.

In order that your wine tasting remains moments to share, WINEMASTER guarantees you a sincere engagement, dedicated expertise and ongoing follow-up at your service!

WINEMASTER.

The WINEMASTER team

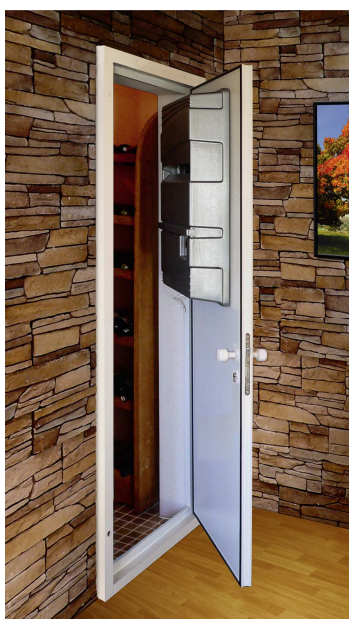

1. GENERAL INFORMATION

1.1. Technical data

Door made of aluminium white painted RAL 9010
Polyurethane-insulation 40 mm

Total weight	62 kg
Capacity	Up to 15 m ³
Dimensions (mm)	2016 x 746 x 2220
Temperature regulation	Pre-set at 4 °C; adjustable between 4 and 15 °C
Maximum outside temperature	35 °C *
Cooling capacity	450 W
Absorbed energy	390 W
Power supply	230 – 240 V
Coolant	R 404 a
Noise level - at 1m - at 3m	42 dB 40 dB

- *As the cooling capacity reduces due to the outside temperature, the ability of the appliance to maintain a temperature of 12°C can suffer when the outside temperature rises to roughly 35°C.*

*In any case, a **permanent temperature of 35°C in the air rejection room must be avoided**. Such a high temperature must be limited, at most, during the summer season only (see §2.2 "air rejection room").*

1.2. Dimensional drawing (in mm)

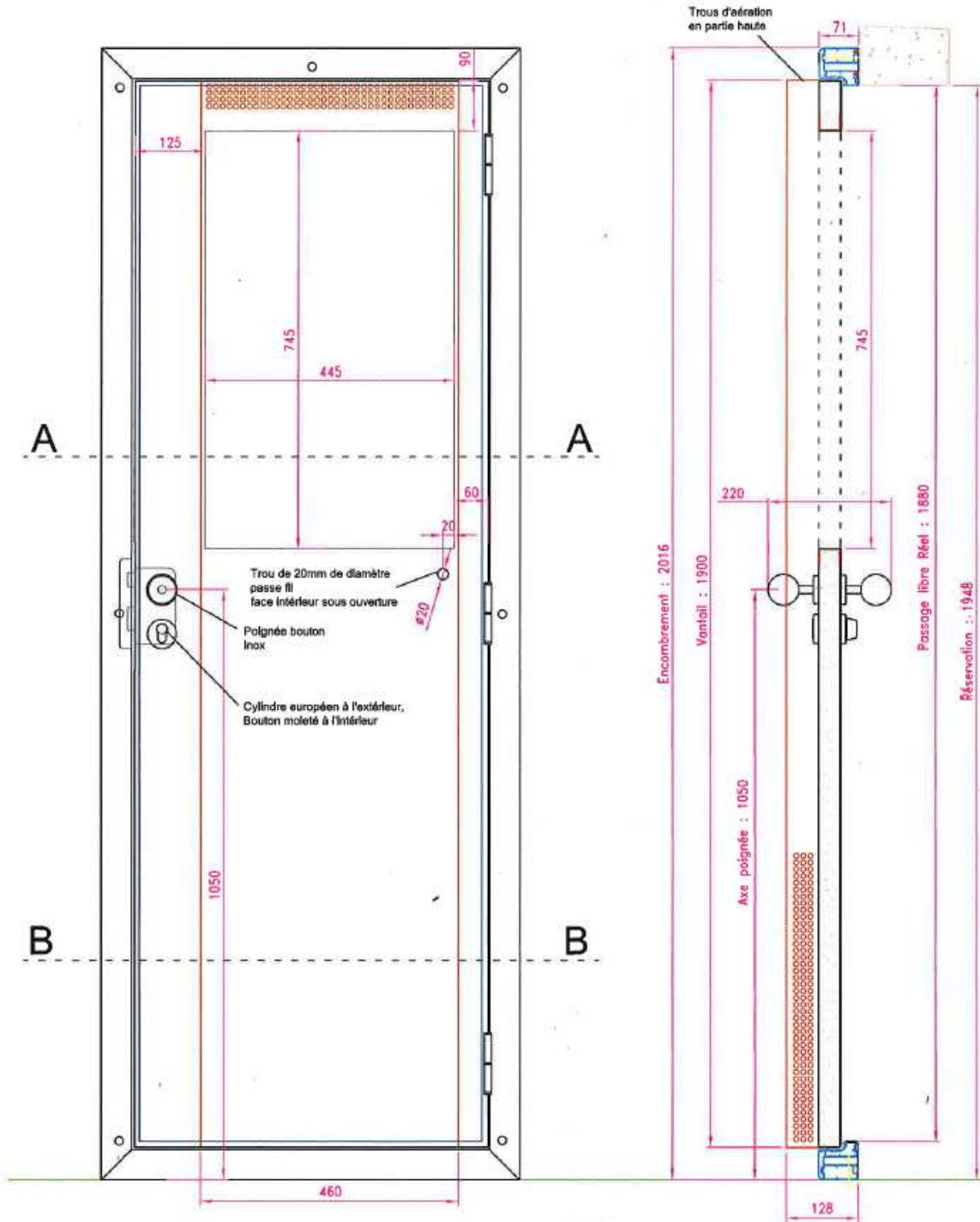

A-A

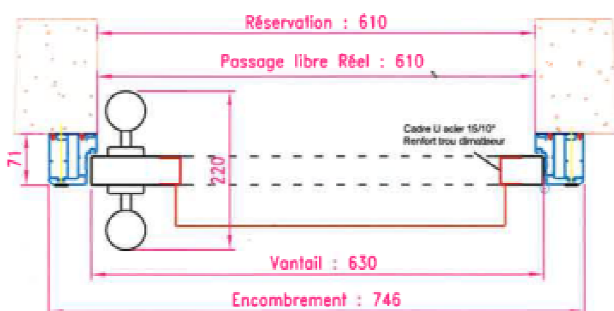

B-B



1.3 Packages content

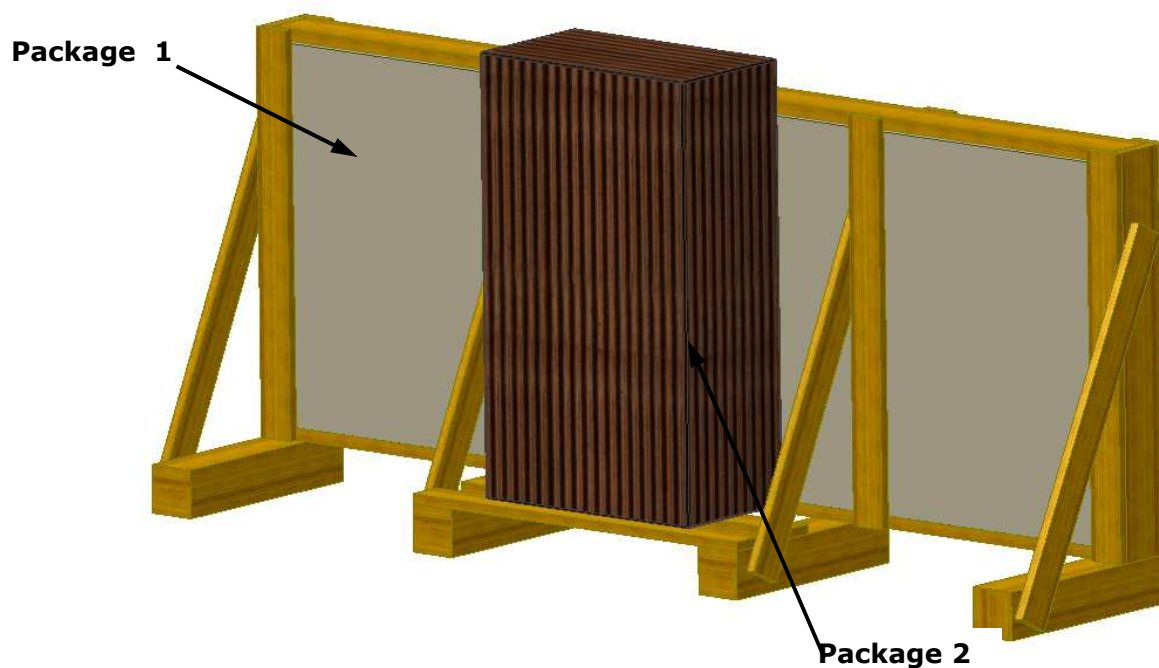

Package 1 :

- 1 set door + frame + hood
- 1 set handle
- 8 fixing screws + plugs
- 8 white plastic covers
- 1 cartridge of silicone
- 1 cylinder + keys set

Package 2 ;

- 1 PC15 air conditioner
- 1 classic hood
- 8 screws for fixing :
 - o 4 for the air conditioner (3.9 x 25 mm)
 - o 4 screws 4 x 50 for the hood
- 4 Flat slice M4
- Condensate pipe (optional installation)
- Manual

Important!!! Check the content carefully at reception.

2. SOME ADVICES

2.1. Wine ageing

The wine must have a place all to itself.

For **the conservation and the ageing of the wine**, the environment has to meet certain conditions.

The stability of the cellar temperature, more so than the temperature itself, is important for good conservation of the wine.

The central heating pipes and a boiler close by are great enemies of the wine. A good cellar should be neither too dry nor too humid.

The effect of dry air is treacherous: it dries the cork, causes a considerable evaporation of the wine through the cork and makes the bottle leaky. Too much humidity favors the growth of mould on barrels and corks.

A humidity level of around 70 % is ideal, but for the wine, the humidity level can vary between 40 and 100 % without degeneration.

The cellar must be closed and protected against vibrations. The shelves or racks must be isolated from all possible sources of vibration and stand on the ground, rather than be attached to a wall which is more sensitive to vibrations.

In order to age, the wine has to be protected from the light. The cellar must therefore be dark and the use of light limited to the bare minimum.

When these conditions are met, the wine will keep for a long time. The cellar will ensure a good maturation and an optimal ageing of the wine.

Wine is not as sensitive as is often thought, **it must above all be protected** from its most important enemies: sudden temperature changes, light ... and those who abuse it!

2.2. Rejection room

- **The "hot" front of the WINEMASTER® must be inside a room.**

The **room**, into which the exhaust air of the WINEMASTER® goes, must be **well ventilated**, so that the maximum and permanent temperature does not exceed 35°C, the ideal temperature being 20°C.

Attention, too little room inside the cellar can result in the hot air being emitted by the air-conditioning, being sucked in again. The outside of the appliance must not be installed in a dip or a space that is too small.

2.3. The cellar

2.3.1 Insulation

Insulation is essential for an efficient functioning of the **WINEMASTER®**.

An adapted insulation enables you to maintain a **stable temperature and humidity level**.

The chart hereunder will allow you to determine the type and thickness of insulation needed in relation to the exterior volume of the cellar and model of the **WINEMASTER®**, for an inside temperature of 12°C.

Complete insulation:

By « tongue and groove » panels or

By panels fused together

IMPORTANT: Avoid the intrusion of heat and humidity which can alter the functioning of the **WINEMASTER®**.

IMPORTANT

The validity of the **WINEMASTER®**-guarantee is closely related to the strict observance of the values in the table "Choice of the insulation" for all the cellar walls including the floor, the ceiling and the door as well as to the perfect continuity of the insulation and an installation according to the instructions.

CHOICE OF INSULATION Wine PC15

MINIMAL THICKNESS OF INSULATION (mm)			
VOLUME OF THE CELLAR (m ³)	EXPANDED POLYSTYRENE $\lambda = 0.044W/m^{\circ}C$	EXTRUDED POLYSTYRENE $\lambda = 0.030W/m^{\circ}C$	POLYURETHANE FOAM $\lambda = 0.025W/m^{\circ}C$
3	45	30	25
6	65	45	40
8	80	55	45
10	100	65	55
12	100	70	60
14	110	70	60
15	110	80	70

INSULATION MATERIALS DATA :

Heat conductivity λ : Unit W/m.°C

- This is a characteristic of the insulating material itself. It certifies the capacity of the material to conduct heat. The lower the coefficient is, the better the insulating capacity is.

- Heat resistance R : Unit m².C/W

- f This is a characteristic of the insulating panel. It depends on the coefficient and the thickness of the insulation.

R = Thickness in meters

λ

It confirms the capacity of the thickness of the insulation to reduce heat transfer.

The higher the coefficient R is, the better the insulation is.

2.3.2 Insulation of walls and ceiling

The producers offer insulation panels of several kinds:

- **insulating panels only**
- **"complex" insulations:** The insulate panel is coated (plaster, mineral...),
- **"Sandwich" panels:** the insulate panel is covered on both sides with a layer of wood or plaster.

IMPORTANT: The facing of the panels is important: it protects the insulate panel against shocks and ensures its durability.

Do not use insulations made of mineral fibers (glass wool, rock wool, etc...) as they can absorb humidity and lose their insulating capacity against the cold.

DO YOU KNOW THAT?

Some insulating materials can be attacked by rodents (mice, rats...). It must therefore be guaranteed that the cellar walls provide no openings through which the rodents can reach the insulation.

These insulations are covered with a protective layer on the inside of the cellar.

→ Polyurethane is an insulating material, which due to its chemical composition, is not attacked by rodents

2.3.3 Insulation of the floor

The cellar floor must be strong enough to carry the shelves and the stored wine.

For this part insulation material must be chosen, which provides sufficient resistance to pressure.

The producers indicate in their documentations if the insulating materials are appropriate or specially designed for floors.

Resistance to perforation (in particular by the feet of shelves) is obtained :

- **by using "complex" insulation panels**, which are covered on the upper side with a sufficiently resistant plate.
- **by facing the insulation panel with chipboard** (thickness ca. 15 mm) or with another adequate cover (floor boards or tiles for example).

2.3.4 Insulation of other elements

Do not put wine cabinet or freezer in the cellar, because they produce heat.

All sources of heat in the cellar, such as central heating pipes, must be insulated.

3. DOOR INSTALLATION

Tools : (not supplied)

1. CROSS HEADED SCREW DRIVER
2. LEVEL
3. PLIER
4. MEASURING TAPE



Dimensions of the wall cutout:

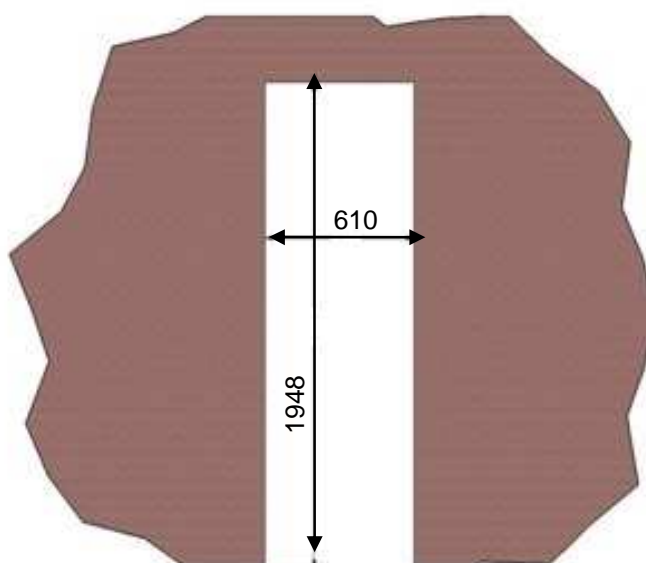

MAKE SURE THE EDGES AND SURFACES OF THE OPENING ARE CLEAN AND SMOOTH.

1. Apply the frame on the wall
2. Fasten the door part at side hinge upright by positioning the level as indicated below.

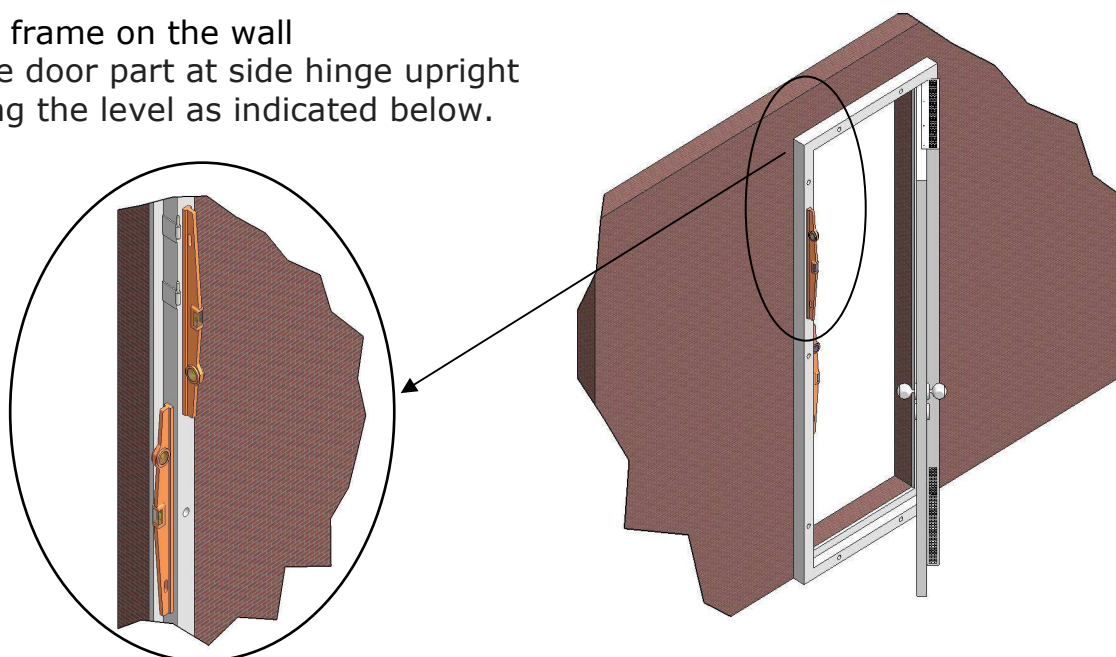

- Place the door on the hinges and adjust the opposite pole.

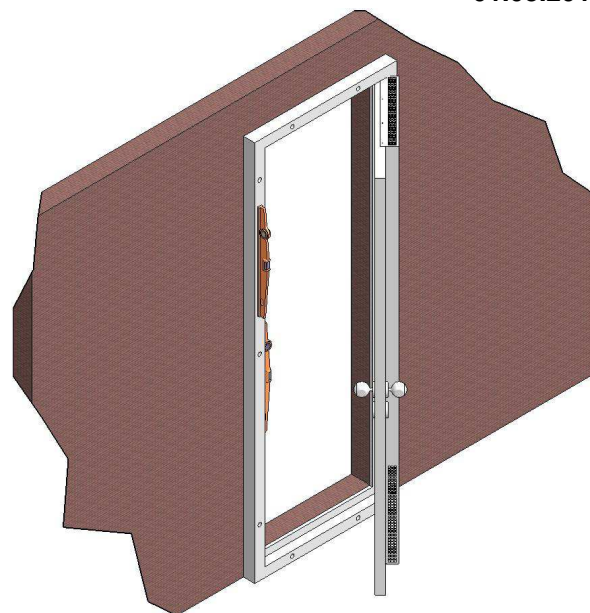

- The door must fit precisely to the frame in order to ensure optimal impermeability. Readjust the door-jamb and the hinges if necessary.

- Check the squaring of the installation and then fix the other sides of the frame.

If necessary you can use glue in addition to the screws. If the frame is to be fixed to dry walls, glue may even be indispensable.

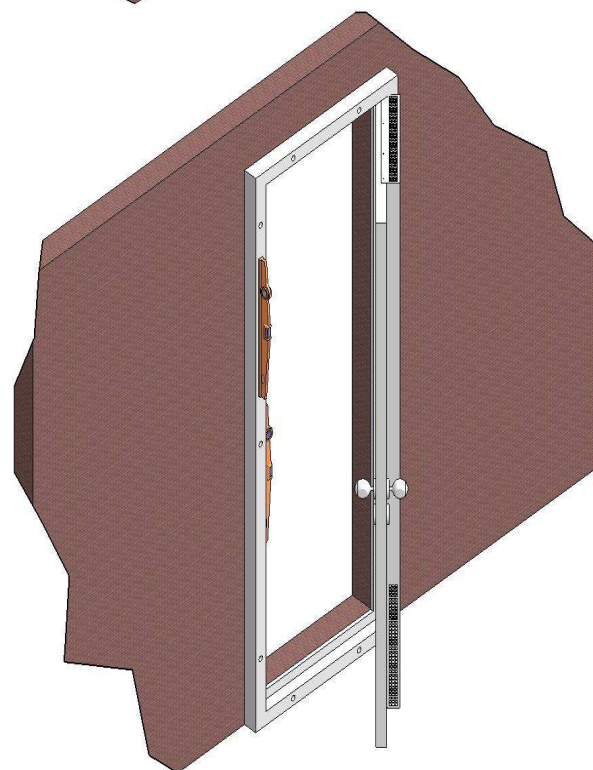

Squaring of the installation - a regular border is important.

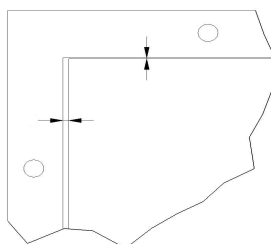

- Seal the space between the frame and the wall with silicone or acryl.

- Cover the mounting holes with the plastic covers provided for this purpose.

- Remove the protective film from the door.

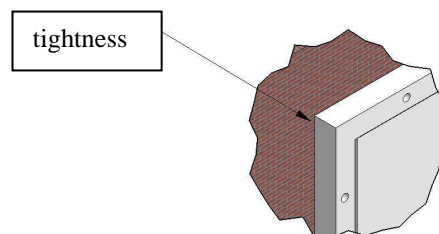

4. INSTALLATION OF THE AIR CONDITIONER

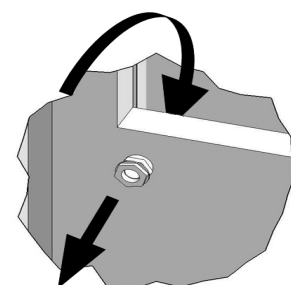
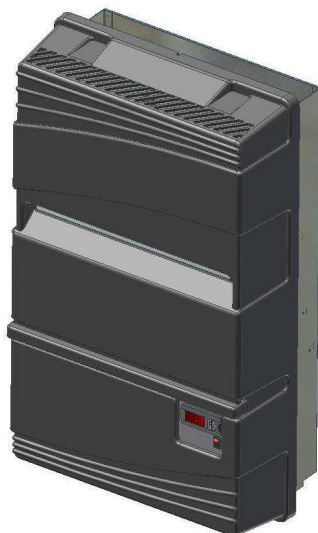

1. Put the power cable through the wire pass situated on the left side of the door opening.
2. Place the air conditioner in the door aperture
3. Check the level of the appliance then fix it on the door with the 4 thread forming screws and the rings. First screw the 2 ones on the top, then the ones on the bottom.



- Fit the cover and fix it with the corresponding screws 4 x 50, 2 at the top and 2 at the bottom of the cover, tightening them in moderate way.

The thermostat is visible through the opening on the cover.



- Plug in the air conditioner.



Important: The connection must comply with current regulations: waterproof case with cable stop, sufficient cable cross-section and protection according to the current installation rules (not supplied).

5. USING THE AIR CONDITIONER





Use the switch (5), to switch the air conditioner on or off

5.1. Temperature setting

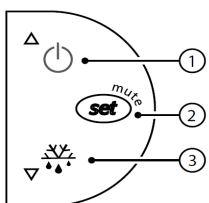
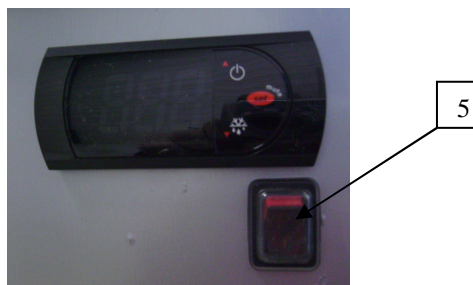
The temperature is adjustable from 4 to 15 ° C.
 It is factory calibrated at 4 ° C.
 For optimal wine storage, the recommended temperature is 12 ° C

- Setting the thermostat: (imperative at first plug in)



- Press on button  one second until the set point temperature flashes.
- Press on button  to increase the set point temperature.
- Use button  to decrease the set point temperature.
- When the setting is correct, press on  to confirm.

Explanations of main display symbols:

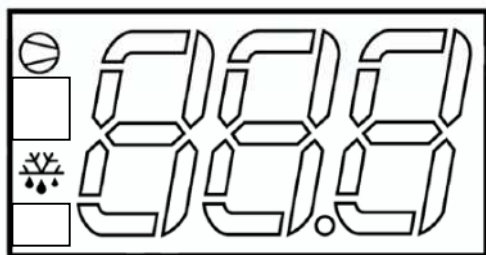

Red light  on the display = cold mode engaged (compressor)

Red light  on the display = defrost mode engaged

5.2. Standby mode

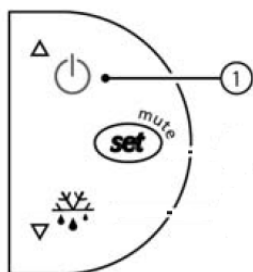

-Standby mode: maintain a 3 seconds pressure on button 1. The compressor stops and the fan turn at low speed.

- The thermostat indicates « OFF » and also the cellar temperature.
- To come back, maintain again a 3 seconds pressure on button 1.
- The thermostat indicates « ON » during 1 second..

5.3. Automatic defrost

The thermostat will run an automatic defrost time several times a day. During this operation, the compressor is stopped, only the fan is functioning at low speed. The condensate water producing during this period will be evacuated through the tube drain.

The display shows « DF » during defrost period.

- Check the installation :

In order to have an optimal functioning of the air conditioner, check that airtight is correctly insured. Check that the door closes tightly. Check also the tightness of the door frame on the wall.

6. AIR CONDITIONER MAINTENANCE

IMPORTANT MAINTENANCE! ! !

It is essential to **check the dust filter every month** and to replace it as soon as necessary and at least once a year. If it is dirty, the air conditioner may be seriously damaged.

How to replace the filter?

1. Remove the filter drawer (E).
2. Pull the tab to release the filter (D)
3. Put the new filter on place
4. Replace the filter cover

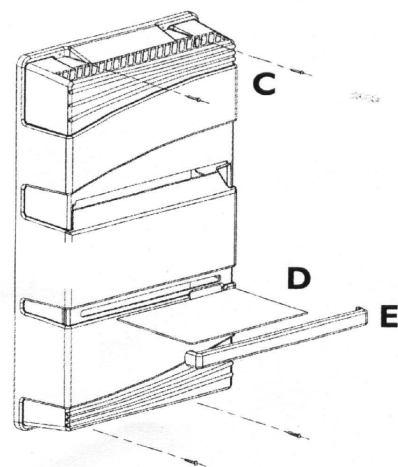

7.WARRANTY

7.1 Contractual warranty

The contractual warranty is not exclusive, the fundraiser for the purchaser profit of the legal warranty against latent defects that applies in terms of articles 1641 and following from the Civil Code.

7.2 2 years contractual warranty

As a supplement to the legal warranty provided under the laws of the purchaser's country, WINEMASTER offers an additional **2 years** contractual warranty against any manufacturing defect.

During this period of contractual warranty, WINEMASTER will replace any parts that have a manufacturer's defect.

In case of electric failure, WINEMASTER reserves the right to send an expert technician to inspect the appliance before replacing any defective parts.

In case of refrigeration failure, WINEMASTER may require that the appliance is returned to the factory for repair. Any interventions will take place according to the guidelines set in the "after sale service" document.

Interventions and returns can only be done after written agreement from WINEMASTER after sale service.

7.3 Warranty conditions

The contractual warranty applies to all appliances installed and used in conformity with this « User Manual ».

His application is conditioned by the presentation of the purchase invoice or for lack of its copy.

7.4 Exclusions and limitations of warranty

The warranty can be refused in the following cases:

- Insulation of the cellar or installation of the appliance not in compliance with the instructions of this guide.
- Damage due to negligence, lack of maintenance or incorrect use of the WINEMASTER® (particularly dirty filters).
- Exchange or repair of parts under warranty will not extend the 2 years warranty period

WINEMASTER cannot, in any case, be held liable for any direct or indirect damages resulting from the failure of the air conditioner. **The warranty is exclusively limited to the product itself provided by WINEMASTER.**



The European Community, attaching a great importance to the environment and the waste processing, set up Directive 2002/96/CE relating to the Electric and Electronic Component waste.

In accordance with this standard, the logo "barred dust bin" is obligatory.

This logo means that **this product cannot be thrown in the household shelter**. It must be given to a suitable collection point for the treatment, valorisation, recycling of Electric and Electronic components.

Acting like that you make a gesture for the environment and you contribute to the safeguarding of the natural resources as well as to the protection of human health.